

Contents

1.	Preface	4
1.1.	Purpose of the user guide.....	4
1.2.	Structure of the user guide	4
1.3.	Associated documentation	4
1.4.	Recommended reading material.....	5
1.5.	Trademarks and patents.....	5
1.6.	Disclaimer.....	6
2.	System overview.....	7
2.1.	System architecture.....	7
2.1.1.	System Layout.....	7
2.2.	SEM interface (SCA).....	8
2.2.1.	Description of parts.....	8
2.2.2.	Dimensions & weights	10
2.2.3.	Serial number	10
2.3.	Spectrometer interface	10
2.4.	Software.....	11
2.5.	Installation requirements	11
2.6.	Safety information.....	12
2.6.1.	Laser safety.....	13
2.6.2.	Electrical safety.....	15
2.6.3.	Mechanical safety	16
2.6.4.	Handling and lifting	17
2.6.5.	X-ray safety.....	17
2.7.	Maintenance and Servicing	17
2.7.1.	Manual retraction of optic transfer tube	18
2.7.2.	Spare parts and consumables	18
2.7.3.	Service and technical assistance	19
3.	Operating instructions.....	20
3.1.	Introduction.....	20
3.2.	Spectrometer set-up	21
3.3.	SEM set-up	23
3.4.	Structural and chemical analyser set-up.....	26
3.4.1.	Motor control and status indication panel.....	26
3.4.2.	Shuttering and attenuating the laser.....	27
3.4.3.	Initialising the VCFOP software	28

3.5. Collecting a spectrum	30
3.5.1. Setting the sample height	30
3.5.2. Moving the sample to the analysis position	34
3.5.3. Setting spectrometer & SCA acquisition conditions.....	35
3.6. Changing Laser wavelengths.....	38
3.6.1. Spectrometer set-up	38
3.6.2. SCA set-up.....	39
3.7. Set-up for VIS/UV-CL and PL spectroscopy	39
3.7.1. Spectrometer set-up	40
3.7.2. SCA set-up.....	40
3.8. Procedure for VIS/UV-CL mapping.....	41
3.8.1. Spectrometer set-up	42
3.8.2. SCA set-up.....	43
3.8.3. SEM and MICA software set-up.....	43
4. Calibration.....	46
4.1. Silicon signal check (system "health check")	46
4.2. Setting the analytical WD.....	46
4.3. Setting the analytical position	48
Appendix A - Specifications.....	52
Appendix B - SEM implementation notes	53
Appendix C – Troubleshooting	54
Appendix D – Weights and dimensions.....	57

List of figures

Figure 1 - SEM-SCA system architecture	7
Figure 2 - The structural and chemical analyser SEM interface	8
Figure 3 - front panel of SCA	9
Figure 4 - End panel of SCA (showing power switch location)	9
Figure 5 - Position of safety and compliance labels on the SCA	12
Figure 6 - Laser Safety Warning Label fitted to removable panels	14
Figure 7 - Class 3B laser advisory label	14
Figure 8 - Laser compliance label.....	15
Figure 9 - Label declaring compliance with EMC/EMI regulations.....	16
Figure 10 - Moving machinery warning label	16
Figure 11 - Warning label fitted to SCA casing.....	18
Figure 12 - Overview of SCA operation and set-up procedures	20
Figure 13 - The WiRE2.0 spectrum acquisition dialog box.....	21
Figure 14 - The WiRE 2.0 sample review dialog box.....	21
Figure 15 - inVia rear arm laser paths (514 SEM + Ship path selected).....	22
Figure 16 - Flowchart showing SEM set-up	23
Figure 17 - Control panel for SCA motorised retraction mechanism	26
Figure 18 - Figure showing the laser shutter control.....	27
Figure 19 - ND filter control icon and toolbar	28
Figure 20 - Video viewer properties dialog.....	28
Figure 21 - Video source dialog.....	29
Figure 22 - Capture Pin Properties dialog box.....	29
Figure 23 - <i>Direct</i> method for setting sample height (analytical WD)	31
Figure 24 - <i>Indirect</i> method for setting sample height (analytical WD)	32
Figure 25 - SCA control program button icon	35
Figure 26 - SCA control program dialog box.....	35
Figure 27 - Probe control toolbar	36
Figure 28 - camera control toolbar.....	36
Figure 29 - Video Source dialog	37
Figure 30 - Image Control dialog	37
Figure 31 - Camera Controls dialog.....	37
Figure 32 - inVia rear arm showing position of steering mirrors	39
Figure 33 - The three-position technique selection mechanism	41
Figure 34 - CCD arm - detector cover in position.....	42
Figure 35 - CCD arm - auxiliary detector in position (lock-screw circled in red).....	42
Figure 36 - The <i>MICA</i> imaging and mapping control dialog box	44
Figure 37 - Flowchart showing <i>indirect</i> positioning of laser spot	49

1. Preface

1.1. Purpose of the user guide

The purpose of this User Guide is to provide information for the safe use of the Renishaw structural and chemical analyser.

Whilst every effort has been made to ensure the safety of the equipment at the design stage, there are still circumstances under which residual risks to the user exist. The risks are highlighted in this user guide.

1.2. Structure of the user guide

This *User Guide* comprises four principal sections:

1. The *preface* gives a brief introduction to this guide as well as some background information
2. The *System Overview* provides more general details about the system including, layouts, annotated drawings of the equipment, installation requirements, safety, and maintenance information
3. The *Operating Instructions* uses a combination of flowcharts and notes, and conventional written instructions to provide a rapid and easy-to-use reference for system operation
4. The *Calibration* section describes how to check that the system is operating nominally, and how to determine the position of the laser spot with respect to the SEM image and the analytical working distance

1.3. Associated documentation

This user guide describes only operations that are specific to the structural and chemical analyser; the following documents should be used for operations relating to the *inVia* spectrometer and SEM control:

- [Online] *inVia* Raman Microscope User Guide (M-9836-0797)
- SEM operation manual (provided by SEM manufacturer)

1.4. Recommended reading material

It is strongly suggested that some basic background material on Raman spectroscopy, both theory and experimental is available to users of the instrument. Suitable texts include:

1. Modern Spectroscopy J M Hollas (Wiley 1992)
2. Introductory Raman Spectroscopy J R Ferraro and K Nakamoto (Academic Press 1994)
3. Practical Raman Spectroscopy D J Gardiner and P R Graves (Springer-Verlag 1989)
4. Analytical Raman Spectroscopy J G Grasselli and B J Bulkin (Wiley 1991)
5. Infrared and Raman Spectroscopy: Methods and Applications B Schrader (VCH 1995)
6. Introduction to Infrared and Raman Spectroscopy N B Colthrup, L H Daley and S E Wiberley (Academic Press 1990)
7. Infrared and Raman Spectra of Inorganic and Co-ordination Compounds K Nakamoto (Wiley 1994)
8. The Handbook of Infrared and Raman Characteristic Frequencies of Organic Compounds Du-Lin-Vien, N B Colthrup, W G Fatley, J G Grasselli (Academic Press 1991)
9. Raman\Infrared Atlas of Organic Compounds B Schrader (VCH)
10. The Raman Spectra of Polymers P J Hendra, J K Agbenyega (J Wiley)

1.5. Trademarks and patents

WINDOWS[®] and Microsoft[®] are registered trademarks of Microsoft Corporation.

WiRE[™] and inVia[™] are trademarks of Renishaw plc.

The following patents and patent applications relate to various features of Renishaw's structural and chemical analyser, the numbers are correct at the time of printing:

EP 0995086 US 2003-0053048 JP 2002-514,747
WO 03/014794

Renishaw's spectrometers are also protected by patents – please

refer to the appropriate documentation for details

1.6. Disclaimer

The contents of this document are valid at the time of issue, but Renishaw plc reserves the right to change the contents and specification without notice.

2. System overview

2.1. System architecture

Figure 1 below shows the overall system architecture for the structural and chemical analyser. The standard length for the armoured conduit that runs from the SCA to the spectrometer and laser is 5 metres or 6 metres, although longer conduits are optionally available.

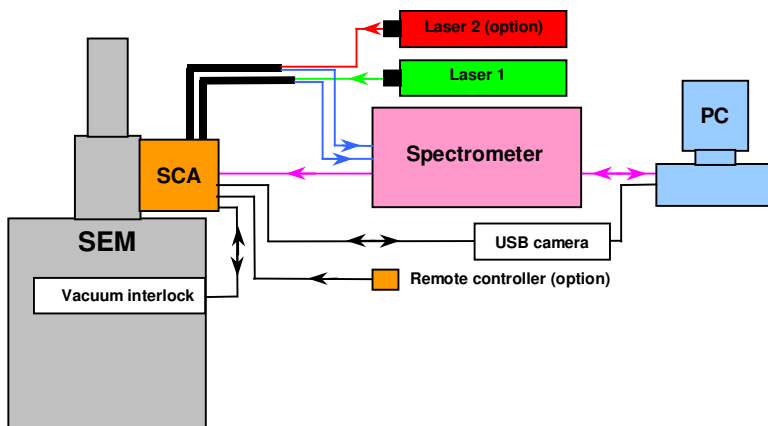

Figure 1 - SEM-SCA system architecture

2.1.1. System Layout

From an operational perspective, it is preferable that the SEM and the Raman spectrometer are located relatively close to each other, but the final layout of the system will depend on the type of spectrometer chosen, and existing SEM laboratory space constraints.

The inVia™ spectrometer can be used as standalone unit, and is supplied with an optical table (the dimensions of which are normally 5' x 3' x 8" – 1524 mm x 896 mm x 203.2 mm); the "footprint" of the Raman system is defined by the optical table. The spectrometer may require class 3B laser safety measures (see section 2.6.1). It is possible to locate the SEM and spectrometer in adjacent laboratories, but this requires a feed-through for the conduit and cables, and under these conditions we would recommend

a second PC with a KVM (keyboard, video, mouse) switch to control the spectrometer remotely from the SEM room.

2.2. SEM interface (SCA)

The structural and chemical analyser (SCA) is principally the SEM interface. Inside the casing there is a motor-driven three-position retraction mechanism, and a video probe, which can have one or two confocal single mode compact fibre optic probes (CSMCFOP) attached to it. Externally there are connections to the spectrometer, computer, and to the SEM electronics for the vacuum interlock.

There is also an armoured conduit (two for a dual-channel configuration) that carries optical fibres for the laser excitation and the Raman signal, and electrical cables for the laser safety interlock. This conduit connects to the *spectrometer interface* (see section 2.3).

2.2.1. Description of parts



Figure 2 - The structural and chemical analyser SEM interface

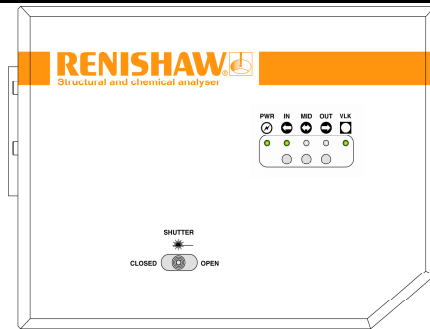

Figure 3 - front panel of SCA

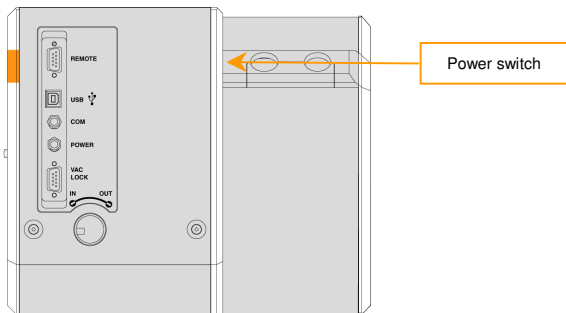

Figure 4 - End panel of SCA (showing power switch location)

The power switch for the system is located in the position shown - the unit should normally be left on so that the safety features remain operational

The operation and function of the *motor control and status indication panel* is described in section 3.4

The operation and function of the *Laser shutter* is described in section 3.5.4

The armoured conduit to the spectrometer interface protects two optical fibres; one for the laser excitation, the other for the Raman signal. The conduit also contains wires for the laser interlock - in the unlikely event that the conduit and the fibres and wires within it were severed, the laser would be shut off.

The functions of the sockets on the *Connector panel* are as follows:

- REMOTE - for the optional remote controller which duplicates the functions of the *motor control and status indication panel* (see section 3.4 for operational information)
- USB - for the WebCam that displays the white-light image with the laser spot
- COM - for the computer control that controls the intensity of the white light illumination, and the operation of the flip-mirror to switch between Raman spectroscopy and white light imaging
- POWER - for the SCA power supply
- VACUUM INTERLOCK - for the connection to the SEM vacuum logic which ensures that the SCA cannot be accidentally damaged by improper use (details of the vacuum interlock are given in section 3.4)

The operation and function of the *Manual retraction for the optic transfer tube* is described in section 2.7.1.1

2.2.2. Dimensions & weights

The drawing (G-9838-0284-01-B) in Appendix D gives the dimensions of the system and its centre of gravity. The weight of a single channel system is approximately 15.0 kg, and a dual channel system weighs 15.5 kg.

2.2.3. Serial number

The serial number of the system is located to the right of the manual optic transfer tube retraction mechanism, please quote this number in any communications with Renishaw plc.

2.3. Spectrometer interface

For inVia *Reflex* and *Standard* models, both the laser and signal fibre connections are made internally and are set-up by the installation Engineer during commissioning. SCA-input (single or dual channel) is simply selected from within the WiRE™2.0 software (see section 3.2.1 for further details), and this drives filters, gratings, and mirrors to reconfigure inVia automatically for the SCA beam paths.

For further information please refer to section 3.2

2.4. Software

The software that controls the SCA – specifically switching between white-light imaging and Raman spectrometry, and controlling the SCA video viewer and illumination control, can either be launched from an icon in the Renishaw WiRE software, or can run as a standalone application running on another more convenient PC (e.g. the SEM control PC). The WiRE software that controls the spectrometer, or the SEM control software is otherwise unaltered, and the relevant sections of the *inVia* spectrometer *user guide* should be referred to for its operation.

Detailed information about the operation of the SCA software is given in the relevant parts of section 3.0

2.5. Installation requirements

All local regulations regarding installation of Class 3B (IIIB) laser system must be followed.

The SCA requires a single electrical supply connection. Please refer to the *User Guide* supplied with the spectrometer to determine how many additional connections are needed.

The room in which the system is installed should be capable of being blacked-out during operation (that is, the internal room lighting and any external light sources should be capable of being extinguished and excluded respectively). Extraneous light may contaminate the data acquired during operation. It is recommended that low-wattage incandescent lamps are available in addition to fluorescent strip lighting, and that any windows are permanently blacked-out and sealed.

In addition to local Health and Safety regulations, the system should be situated so that mechanical vibration and acoustic noise do not affect the system stability - SEM installation requirements are satisfactory in this respect.

The system should be situated such that air-borne particles (dust) do not heavily contaminate the system optics, resulting in a possible reduction of the operational efficiency of the system. Keep the spectrometer door closed (or the covers in place) to keep the optics clean. **Do not attempt to clean any optics before contacting Renishaw (or authorised dealer, agent, distributor or subsidiary).**

Operating conditions: 20-30°C (stable to $\pm 2^\circ\text{C}$)
 <90% RH (non-condensing)

The SCA drive mechanism does not generate sufficient heat to require venting or cooling (even for a duty-cycle close to 100%). The spectrometer and laser, however, will generate moderate amounts of heat so air-conditioning may be necessary to maintain room temperature stability.

2.6. Safety information

Under normal operating conditions the SCA itself presents no hazards to the operator. The SCA, however, is designed for use with a spectrometer that uses a Class 3B laser (as defined by International Standard IEC 825:1993, CENELEC Standard EN60825:1994, and US Standard 21 CFR 1040.10), and for this reason the SCA is a class 3B laser product.

The SCA is powered by a third party (and hence fully certified) power supply unit, which delivers the 36V used by the SCA. This low operating voltage means that the SCA falls into the same category as battery powered devices.

Although the SCA has moving parts, these are enclosed during normal operation, and are only potentially hazardous when the mechanism is exposed during installation and maintenance. These safety considerations are reflected in the labelling of the SCA; the figure below shows the positions of the safety and compliance labels.



Figure 5 - Position of safety and compliance labels on the SCA

2.6.1. Laser safety

The spectrometer will normally be supplied with the laser, although the type, model, and characteristics of the laser may vary among different systems/applications or at different times. **Lasers other than those provided by Renishaw may be suitable for use with the system, but this must be confirmed through Renishaw plc before installation. If a high-power laser (not provided by Renishaw) is used, additional risks will arise; in particular the laser power visible through an SEM viewport may exceed Class 1 AEL (Accessible Emission Limit) which would contravene the above standards and introduce a significant risk of laser damage to the eyes of the operator.**

For details of the maximum output power and emitted wavelengths of your laser, refer to the user instructions/manual issued with the laser in use with the spectrometer.

Class 3B lasers are potentially hazardous if a direct beam or specular reflection is viewed by the unprotected eye. Precautions should be taken to avoid direct beam viewing, and to control specular reflections.

When the SCA is operated under standard conditions, the laser beam is completely enclosed within the system except as it leaves the parabolic mirror in the SEM. The risk of exposure will therefore only occur under the following circumstances:

- As specular reflection from the beam as it leaves the laser and enters the back of the spectrometer (unless the laser path is fully enclosed). **Access to this region, particularly of reflective objects should be strictly controlled.**
- As specular reflection from the sample if the SEM has a viewport with line of sight to the sample. The beam will be focused by the parabolic mirror to a point just below the optic transfer tube and will rapidly diverge thereafter. This divergence means that any laser radiation visible through a viewport is at least an order of magnitude below the Class 1 AEL (Accessible Emission Limit).
- If the user defeats the interlock switches on the spectrometer door or if the user removes the various access covers or blanking plugs on the SCA unit whilst the laser is turned on. Warning labels as shown

in Figure 6 identify the access cover. **The SCA covers are for servicing only and should not be removed.**

Access to the spectrometer is via a key operated lock on the front door, or via panels that need to be removed using a tool. These measures are implemented to prevent unauthorised access to the laser beam within the unit. The spectrometer should be kept locked, or with covers in place during normal operation and should only be unlocked or uncovered by a person authorised to do so. Access to the internal parts of the spectrometer or the SCA should be limited to experienced personnel with a sound working knowledge of Class 3B laser safety guidelines (for example Section 3 of EN 60825:1994). A copy of the relevant standard or guidelines should be kept in the area where the SCA and spectrometer are located.

Additional laser safety information relating to the spectrometer are contained within the spectrometer *User Guide*.

Labels fitted to the SCA advise operators are that the product is laser class 3B, and are fixed to removable panels and also fixed internally such that they are clearly visible if the panel is removed, examples are shown below.



Figure 6 - Laser Safety Warning Label fitted to removable panels



Figure 7 - Class 3B laser advisory label

The label below declares that the SCA complies with the relevant laser safety standards required by the US Government.

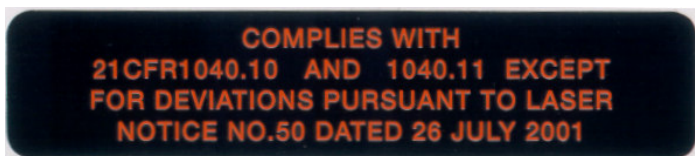

Figure 8 - Laser compliance label

2.6.2. Electrical safety

The SCA is supplied with a three-wire mains power lead (power cord) terminated at one end by an IEC socket which fits into the power supply for the SCA unit. The lead supplied follows one of three configurations dependent upon customer requirements. The three configurations are:

1. IEC connector to UK 13A plug.
2. IEC connector to US or Australian 3-pin mains plug.
3. IEC connector to European Schuko plug.

WARNING

THERE ARE NO USER-SERVICEABLE PARTS OR ADJUSTMENTS THAT CAN BE MADE TO THE ELECTRICAL ASSEMBLIES WITHIN THE SCA UNIT. REMOVAL OF ANY COVERS MAY EXPOSE A DANGER OF ELECTRICAL SHOCK

The SCA system is powered by a third party universal input power supply with the following specification:

Input:	100 V to 240 V AC; 47 Hz to 63 Hz; 1.2 A
Output:	36 V DC; 50 W maximum
Safety Approvals:	UL1950, CSA 22.2 No.234, EN60950
	EMC: CISPR22 Class B, FCC20780 Level B

CAUTION

Associated equipment (for example microscope, laser, computer and peripherals, etc.) may be separately powered and may be set for a specific voltage range other than above.

The SCA conforms to EN61326:1997, FCC CFR47 & BS EN 61010-1:2001

This device complies with Part 15 of the FCC Rules.
Operation is subject to the following two conditions:
(1) This device may not cause harmful interference, and
(2) This device must accept any interference received,
including interference that may cause undesired
operation.

Figure 9 - Label declaring compliance with EMC/EMI regulations

2.6.3. Mechanical safety

When the SCA panels are attached, no mechanical hazard is presented to the user. There are, however, moving powered parts within the spectrometer, which pose a crushing hazard (for example, to fingers). Under normal operating conditions, the SCA should *never* be used with any covers removed.

During alignment the SCA must be operated with the panels removed, during this process great care should be taken to keep fingers etc. away from moving parts. **Alignment should only be carried out by trained Renishaw Engineers.**

When the covers are removed the label below indicates that there are moving parts that might be hazardous.



Figure 10 - Moving machinery warning label

WARNING

IN THE PERIOD IMMEDIATELY FOLLOWING POWER ON, THE SCA FIRMWARE INITIALISES, AND THE MOTORS MAY UNDERGO A RAPID PRE-PROGRAMMED MOVEMENT LASTING A FEW SECONDS. IF THE PANELS ARE REMOVED, GREAT CARE MUST BE TAKEN TO KEEP FINGERS ETC. AWAY FROM THE MOVING PARTS.

2.6.4. Handling and lifting

The SCA may only be installed by Renishaw Engineers or installation Engineers trained and approved by Renishaw. Any subsequent movement or lifting of the unit is done at the user's risk.

WARNING

IF THE SCA IS DETACHED FROM THE SEM, ITS WEIGHT MUST NEVER BE SUPPORTED BY THE IN-SEM OPTICS TRANSFER TUBE. THIS WILL IRREPARABLY DAMAGE THE OPTICS REQUIRING EXCHANGE OF THE ENTIRE COLLECTION OPTICS ASSEMBLY. NOTE: ONCE THE UNIT HAS BEEN MOVED, IT WILL ALSO NEED TO BE REALIGNED.

2.6.5. X-ray safety

The Ionising Radiation Regulations 1999 (ISBN 0 7176 1746 7) state that the maximum permissible annual dose for X-rays is 20 milli-Sieverts (this translates to 3.805×10^{-8} Sieverts per hour, or 0.038 micro-Sieverts per hour). In practice it is not expected that persons would be exposed to the radiation source 24 hours per day 365 days per year, and so a maximum dose rate is set at 7.5 micro-Sieverts per hour [HSE Information Sheet: Industrial radiography – managing radiation risks].

Calculations and experimental measurements¹ show that even under worst case experimental conditions, X-ray emissions from the SCA (even with covers removed) are below harmful levels.

2.7. Maintenance and Servicing

WARNING

DO NOT REMOVE COVERS, THE SCA CONTAINS NO USER SERVICEABLE PARTS - REFER SERVICING TO QUALIFIED PERSONNEL. UNAUTHORISED REMOVAL OF COVERS INVALIDATES THE WARRANTY AND CALIBRATION

¹ Tests carried out by JEOL Technics Ltd., and Nanotechsys PTY

This warning is echoed by the label shown below that is fitted to the SCA casing

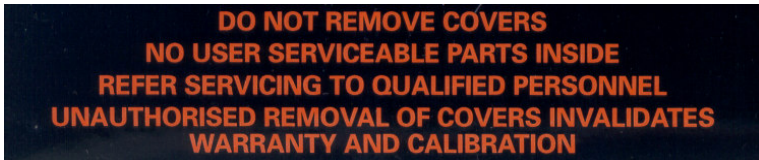

Figure 11 - Warning label fitted to SCA casing

2.2.1. Manual retraction of optic transfer tube

Pressing the control buttons on the front panel or remote (see section 3.4 for details) normally activates insertion and retraction of the optic transfer tube. In the event of power failure, however, the tube can be retracted manually using a flat-bladed screwdriver. This operation should only be carried out if absolutely necessary (i.e. if the SEM chamber is to be vented) since it works against the mechanism's braking system.

2.2.2. Spare parts and consumables

Spare parts for the SCA include the following items:

- In-SEM touch-alarm mechanism
- In-SEM vacuum mirror
- Complete factory-aligned optics transfer tube assembly

Users should not attempt to exchange these parts themselves, and under no circumstances should any attempt ever be made to clean either the vacuum-side or air-side mirrors.

There are a number of consumable items associated with the SCA, the most significant of which is the edge-welded vacuum bellows which has a projected lifetime of 6000 full insertion and retraction cycles. The bellows assembly can be quickly exchanged by qualified Renishaw service personnel without affecting the system alignment, and will be combined with preventative maintenance to exchange motor drive belts. The LED that provides white-light illumination for the VCFOP has a design lifetime of 60,000 hours, but this can also be replaced if necessary.

2.2.3. Service and technical assistance

In the event that there are any difficulties or problems with the SCA, please contact your local Renishaw office or agent - names and addresses for which can be found on our website at www.renishaw.com. The SCA contains no user-serviceable parts, and any adjustments to the mechanisms within the unit will dramatically compromise its performance.

3. Operating instructions

3.1. Introduction

The operating instructions for the structural and chemical analyser are a combination of conventional written instructions, and a series of flowcharts with notes, which are intended to provide a quick and easy-to-follow overview of various procedures, and also to provide a rapid means of accessing the more detailed information.

Each flowchart has a set of notes associated with it that describe the individual operations in detail, and draw the user's attention to any safety considerations or cautionary instructions. The flowchart below gives an overview of the various setting up procedures that need to precede collecting spectra.

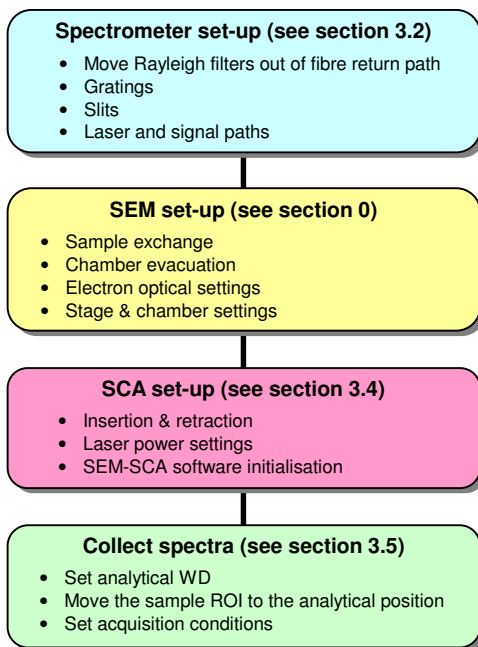

Figure 12 - Overview of SCA operation and set-up procedures

3.2. Spectrometer set-up

Setting up inVia *Standard* or *Reflex* spectrometer models for use with the SCA is very straightforward. During SCA installation, the laser and signal fibres are connected to the spectrometer, and the laser and fibre-probe light path(s) are aligned and programmed into the spectrometer configuration.

The *inVia* software treats the SCA as a different laser type (or different laser types for dual-channel systems). When one of these is selected from within the WiRE™2.0 *Spectral acquisition set-up* dialog box (shown in Figure 13 below) or the *Sample Review* dialog box (shown in Figure 14 below), then the appropriate beam paths and default spectrometer acquisition conditions are set up automatically (remove Rayleigh filters from beam path, and select the appropriate grating). The system may prompt for exchange of lens sets. Please also refer to the inVia spectrometer *User Guide* for further details

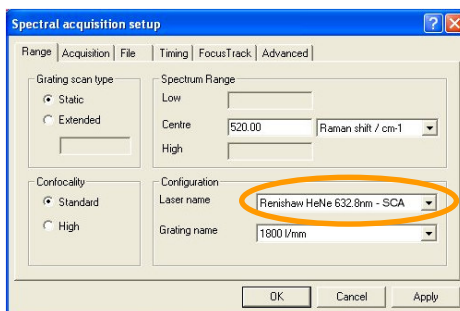

Figure 13 - The WiRE2.0 spectrum acquisition dialog box

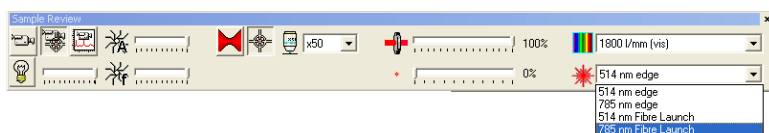

Figure 14 – The WiRE 2.0 sample review dialog box

The spectrometer slit will automatically be set to 70 micrometres for Raman probes, and 350 micrometres for CL probes (refer to the inVia spectrometer [online] *User Guide* for further details) for optimum performance. At the beginning of a series of SCA measurements, it is recommended that a *system "health check"* be carried out using the silicon

calibration sample (see 4.1 for details).

It is also necessary to ensure that the correct laser paths are selected on the inVia rear arm (this is the grey square-section box behind the main spectrometer and placed perpendicular to the laser paths).

Depending on the laser wavelength selected, the appropriate kinematic mirror assembly should be set to the *SEM + Ship* position (see Figure 15 for details).

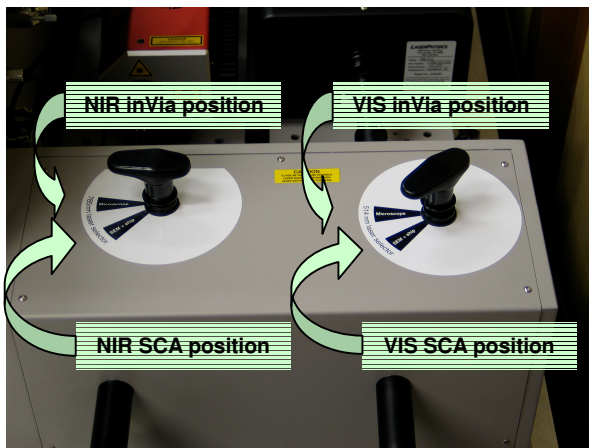

Figure 15 - inVia rear arm laser paths (514 SEM + Ship path selected)

3.3. SEM set-up

The basic operating procedure is shown in Figure 16. This procedure assumes that the SEM has *not* been previously used with the SCA.

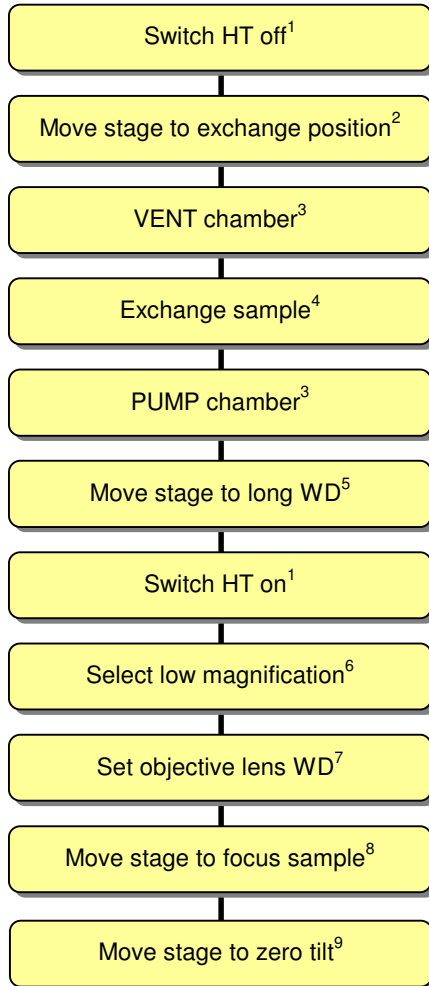

Figure 16 - Flowchart showing SEM set-up

The precise set-up of the SEM will always be specific to the manufacturers' make and model, details of which may be found in their *SEM user guide* and also [Appendix B](#). Nevertheless, there are basic set-up requirements that are generic, some of these are hardware operations, some are driven by software, and some can be adjusted either manually or by computer control. The following notes relate to the steps above; users should pay particular attention to notes 5, 7, and 9.

1. The SEM HT needs to be switched off before samples can be exchanged *unless* the column and chamber are pumped separately (as is common for FEG-SEMs). Further information will be found in the *User Guide* provided by the SEM vendor.
2. If the SEM has a fast entry lock for exchanging samples, then the stage must be moved to a particular exchange position - this position may be pre-programmed into the memory of a motorised stage, or may have to be set manually. Further information will be found in the *User Guide* provided by the SEM vendor.
3. The SCA includes a vacuum interlock, which, if implemented, prevents the chamber from being VENTED unless the collection optics are fully retracted. Similarly, the SCA retraction mechanism controls are deactivated until the chamber is fully pumped (see section 3.4.1 for more details). Details regarding the VENT and PUMP operations of the SEM will be found in the *User Guide* provided by the SEM vendor.
4. For certain SEM models, Renishaw may provide a custom sample holder or insert - this will include calibration samples, and positions for standard SEM sample stubs. **The use of other sample holders means that special attention must be paid to the sample height with respect to the holder to avoid damaging the SCA collection optics. IMPORTANT: If the sample is in too high a position, damage to the SCA collection optics may be caused on their insertion.** The SEM stage may have a working distance (WD) indication marked upon it, but this is normally referenced to the top surface of a standard sample holder - if samples protrude above the top surface of the sample holder, the stage markings cannot be used. The SCA collection optics are designed to work at **one analytical WD** - the WD referred to here is the objective lens WD, specifically the distance from an in-focus surface (normally the sample) to the objective lens. Typically the *analytical WD* is 15-20mm depending on

the SEM model (see [Appendix B](#) for more details). When exchanging samples it is important that the sample is not positioned so that it is higher than the *analytical WD* (i.e. the actual WD is less than the *analytical WD*) otherwise there is the risk that when the SCA collection optics are inserted they will hit the sample causing possible damage.

To prevent the possibility of damage the stage Z control should be set to a long WD so that there is minimal danger of hitting the sample when inserting the collection optics - see [Appendix B](#) for more details.

5. Step 5 above will mean that the sample is likely to be out of focus, so a low magnification (< x100) should be set so that it is easy to see when the sample is coming into focus.
6. This step is the "coarse Z" setting of the WD, and is designed to get the sample close to the *analytical WD*. All modern SEMs have an indication of the WD (specifically the distance from an in-focus surface - normally the sample - to the objective lens), and some enable it to be set directly - further information will be found in the *User Guide* provided by the SEM vendor. If the WD cannot be set directly, the focus control of the SEM should be adjusted until the correct WD setting is indicated. The objective lens (OL) WD should be set to a value 2 mm greater than the *analytical WD* (for example if the *analytical WD* is 15 mm, set the OL WD to 17 mm).
7. Once the OL WD has been set, simply move the stage Z to focus the sample - *do not change the focus settings of the SEM since this will change the effective WD.*
8. **IMPORTANT - Move the stage to zero tilt otherwise damage may be caused to the collection optics.**

It is recommended that unless the samples to be analysed are similar in size and shape, that they be introduced separately into the SEM chamber.

This is to prevent the possibility that tall samples will interfere with the collection optics when attempting to analyse short ones.

3.4. Structural and chemical analyser set-up

This section describes the controls associated with the structural and chemical analyser and relates principally to inserting and retracting the collection optics, and shuttering or attenuating the laser.

3.4.1. Motor control and status indication panel

The figure below shows the controls for the SCA motorised insertion and retraction mechanism, it also shows the vacuum and power status indicators. These controls are duplicated on the optional remote controller for the SCA.

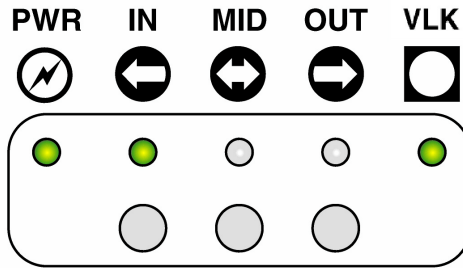

Figure 17 - Control panel for SCA motorised retraction mechanism

The function of these indicators and controls are as follows:

- PWR (power indicator) - this indicator shows whether there is power to the SCA (refer to Figure 4 for the power switch position), if there is no power then the other SCA controls will not work.
- Position indicators IN / MID/ OUT - the LED indicators show the movement status, if the LED is continuously illuminated, then this indicates the collection optics are at that position, if the LED indicator is flashing this means the collection optics are moving to the position indicated by the flashing LED. Movement is actuated by pressing the button that corresponds to the desired collection optics position.

- The IN button moves the collection optics to the fully-inserted position (for white-light imaging and Raman spectroscopy).
- The OUT button moves the collection optics to the fully-retracted position (the "safe" condition for sample exchange and power off).
- The MID button moves the collection optics to a "standby" position approximately 50 mm back from the fully-inserted position. This position completely removes the collection optics from the SEM beam path allowing BE imaging using an annular detector - the optics can be rapidly re-inserted (< 2 seconds) so that Raman spectroscopy can be carried out.
- The VLK (Vacuum indicator) when illuminated shows that the SEM is at its working vacuum, and fully enables all of the motor controls described above; the **VENT** function of the SEM may be disabled (depending on SEM model) if the optics are in the IN or MID positions (the SEM cannot be vented unless the collection optics are fully extracted). If the vacuum indicator is **not** lit, then the IN and MID buttons are disabled (the collection optics cannot be inserted unless the SEM is at its working vacuum). If the SEM vacuum fails during operation, the SCA will automatically fully-retract the collection optics as a safety precaution.

3.4.2. Shuttering and attenuating the laser

The SCA provides a manual shutter for the laser radiation, and also to attenuate the laser power. Please refer to **Figure 18** below for the positions of the shutter and attenuator.

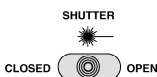

Figure 18 - Figure showing the laser shutter control

If the shutter selection knob is positioned to the right then the laser shutter is *open*, if it is positioned to the left, then the shutter is *closed*.

The inVia spectrometer provides a series of software-controlled ND (neutral density) filters to attenuate the laser power (separate filters for each laser).

During installation of the WiRE™ 2.0 software an icon is set up to activate the ND filter control utility. The icon, and the toolbar it displays are shown in Figure 19 – pressing the appropriate button selects the filter.

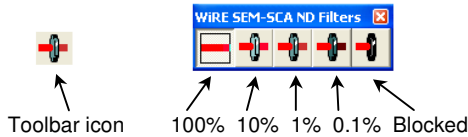

Figure 19 - ND filter control icon and toolbar

3.4.3. Initialising the VCFOP software

The VCFOP program is either called from WiRE™2.0, or can run as a standalone application on another PC. Software initialisation is required the *first* time the software is used after the PC running WiRE™ (or the standalone application) has been switched off, or if the USB camera cable to the PC or the SCA has been or become disconnected for any reason.



Press the SCA software button (shown left) to start the VCFOP control program, the image area will be represented by a white rectangle, right click the mouse inside this area and then left click the mouse on *properties* which will display the dialog box shown below.

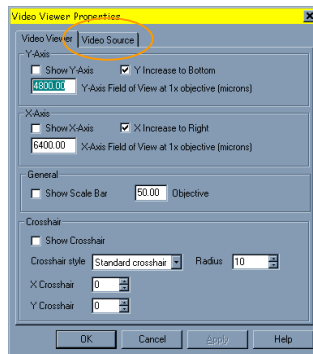

Figure 20 - Video viewer properties dialog

Click on the *Video Source* tab (circled orange in Figure 20) to display the dialog shown in Figure 21.

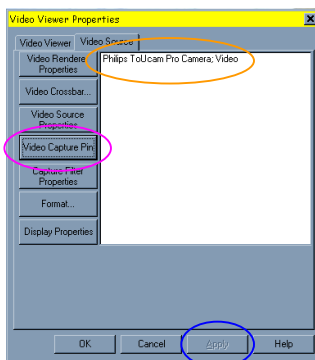

Figure 21 - Video source dialog

Click on the camera identifier (circled in orange in Figure 21) to highlight it then click on the *Apply* button (which will not be greyed) circled in blue in Figure 21, finally click on the *Video Capture Pin* button (circled in magenta in Figure 21) to display the dialog box shown in Figure 22.

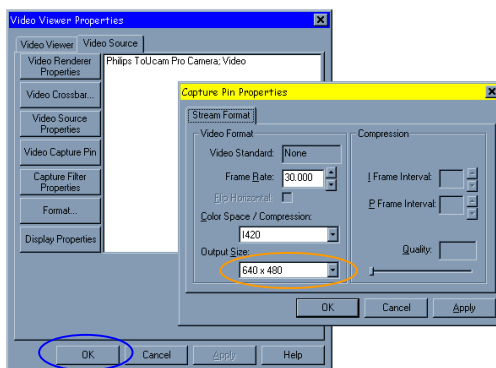

Figure 22 - Capture Pin Properties dialog box

Click on the *Output Size* drop-down box (circled in orange in Figure 22), and select 640x480 resolution (320x240 is the start-up default), click on *OK* and finally click on *OK* in the *Video Viewer Properties* dialog (circled in blue in Figure 22) - the VCFOP software is now initialised.

3.5. Collecting a spectrum

Preparations to collect a spectrum involves three principal operations:

- Positioning the sample at the analytical height
- Moving the point of interest on the sample to the analytical position
- Setting the spectrometer acquisition conditions

Once these operations have been carried out, a spectrum can be collected. If the sample is flat, then the first operation need only be carried out at the beginning of the analytical procedure, similarly, if the signal levels from the sample are comparable, then the third operation need not be repeated. Once the preparations have been completed, subsequent spectra can be collected far more quickly.

3.5.1. Setting the sample height

This operation is critical to the effectiveness of the spectrum collection process. The aim of this operation is to set the point on the sample that is to be analysed at the focal point of the collection optics. The depth of field of the collection optics is in the order of 10 micrometres to 20 micrometres so this operation must be carried out accurately in order to get a good Raman spectrum.

There are two methods that can be used to set the sample height - the *direct* method uses the white-light image to view the sample and the laser spot projected onto it, whereas the *indirect* method uses the SEM objective lens to define the analytical working distance. Which of the two methods that is most suitable will often depend on the nature of the sample, but also the nature of the SEM implementation.

Generally the *direct* method is easier and quicker to set-up, but highly topographic, transparent, or low-contrast samples can be difficult to image using white light, or the laser spot may be too diffuse to focus accurately.

The *indirect* method will work for any sample and can be highly accurate, but may be cumbersome for certain SEM implementations (see [Appendix B](#) for specific information).

The flowchart below show the steps involved for the *direct* method.

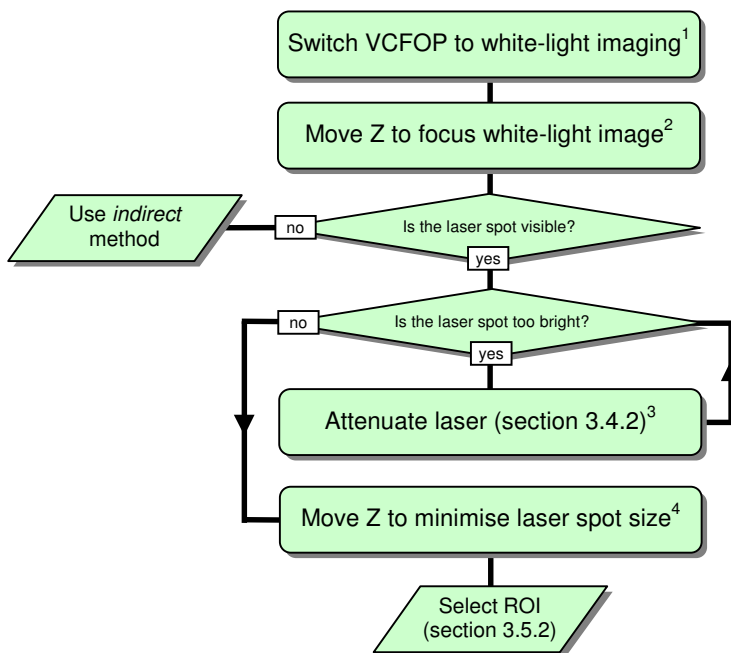

Figure 23 - *Direct* method for setting sample height (analytical WD)

1. Use the SCA control program (see section 3.5.3) to select video mode for the VCFOP.
2. A bright area should be visible, then *slowly* move the stage upwards until the white-light image is focussed. Alternatively, the laser spot can be used to determine how far the sample is from the *analytical WD* - the spot size will decrease to a minimum when the *analytical WD* is reached (thereafter it will get bigger again). If at this stage, either the white light image cannot be focussed, or the laser spot is not visible, the *indirect* method should be used.
3. If the sample is very reflective, the image of the laser spot may overwhelm the white-light image. Refer to section 3.4.2 (Shuttering

and attenuating the laser) for details about how to reduce the laser intensity. Once the laser intensity is acceptable move to step 4.

4. Carefully make fine adjustments to the stage Z control to minimise the laser spot. The sample is now at the *analytical WD* and the region of interest on the sample can be moved to the analysis position (3.5.2).

IF THE TOUCH ALARM SOUNDS

This indicates that the sample (or some part of the sample holder or stage) has contacted the touch sensor on the bottom of the collection optics. DO NOT MOVE THE STAGE ANY HIGHER otherwise the collection optics may be permanently damaged. Move the stage down - if the sample caused the alarm to sound, it is approximately 0.5 mm above the *analytical WD*.

The flowchart below show the steps involved for the *indirect* method.

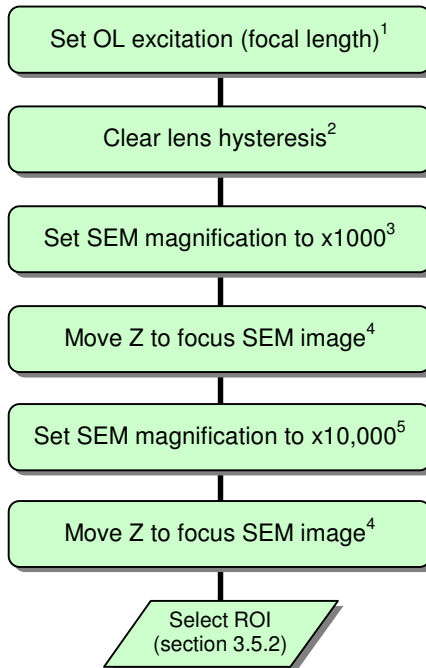

Figure 24 - *Indirect* method for setting sample height (analytical WD)

1. The objective lens (OL) of the SEM may be thought of as a variable focal length lens, and the *indirect method* simply sets the focal length equal to at *analytical WD*. The focal length of the SEM OL is commonly referred to as the working distance and is normally equal to the physical distance between the bottom of the objective lens and the in-focus part of the sample. The working distance of the OL is adjusted using the focus control.

For some SEMs the OL excitation (focal length) can be set directly via a *set WD* function, or by setting directly the coarse and fine DAC (digital to analogue converters) values that drive the lens. If no such function exists, then the focal length must be set-up using a sample for which the *direct* method works (e.g. bare silicon), and then *without touching the SEM focus control* move to the sample for analysis and continue to the next step.

Specific information about which of the methods above are used for a particular make and model of SEM may be found in [Appendix B](#)

2. Electromagnetic lenses can become slightly magnetised over a short time, especially if the lens excitation is frequently ramped from maximum to minimum. As a result, the focussing effect becomes non-linear, and a given excitation may not result in the desired focal length. This phenomenon is known as hysteresis, and to remove it the lens is temporarily grounded - the *Lens Clear* operation. The *SEM Users' Guide* will give information about how to clear the lenses.
3. The SEM magnification should be set to an "intermediate" magnification (for example x1000) that is suitable for coarse focus adjustment - the error in Z setting is in the order of 20 micrometres to 30 micrometres.
4. *Without touching the SEM focus control* the stage Z should be carefully adjusted to bring the SEM image into focus - this is the coarse focus adjustment.
5. The SEM magnification should be set to a "high" magnification (for example x10,000) that is suitable for fine focus adjustment - the error in Z setting is in the order of 2 micrometres to 3 micrometres.

6. *Without touching the SEM focus control* the stage Z should be carefully adjusted to bring the SEM image into focus - this is the fine focus adjustment.

IF THE TOUCH ALARM SOUNDS

This indicates that the sample (or some part of the sample holder or stage) has contacted the touch sensor on the bottom of the collection optics. **DO NOT MOVE THE STAGE ANY HIGHER** otherwise permanent damage may be caused to the collection optics. Move the stage down - if the sample has caused alarm to sound, it is approximately 0.5 mm above the *analytical WD*.

The *analytical WD* has now been set, now the region of interest on the sample to be analysed needs to be moved to the analytical position, this is described in the section that follows.

3.5.2. Moving the sample to the analysis position

The SCA projects a small laser spot to a precise position in X, Y, and Z in the SEM chamber. This position can be restored repeatedly when the SCA optic transfer tube is inserted into the beam path.

Unlike EDS analysis, however, the *Raman analytical position* (where the laser spot is incident on the sample) cannot be moved with respect to the image. The sample has to be physically moved using the X, Y, and Z controls of the SEM stage so that the region of interest is brought to the *Raman analytical position*. How the *Raman analytical position* is indicated on the SEM image depends on the type of SEM to which the SCA is fitted, SEM-specific details are given in [Appendix B](#).

For any SEM, however, it is important to note that the SEM image can move for a number of reasons. In particular the image position is sensitive to probe current and accelerating voltage; the SEM-specific implementation may limit defining the *Raman analytical position* to a few specific accelerating voltage/spot size (probe current) conditions.

According to the SCA specification, the *Raman analytical position* will be within 15 micrometres of the electron optical axis (i.e. the centre of the SEM image display provided no beam shift is present). This means that the *Raman analytical position* will appear to move as the magnification is changed; unless this shift can be programmed into the SEM display, the

SEM-specific implementation may limit defining the *Raman analytical position* to a few magnifications. Both voltage/spot-size and magnification limitations are detailed in [Appendix B](#).

3.5.3. Setting spectrometer & SCA acquisition conditions

The software used to control the *spectrometer* is described in the spectrometer *User Guide* and users should refer to that document to determine how to set up the spectrometer for spectrum collection.

The software that controls the VCFOP (Video Compact Fibre Optic Probe) is called *VidProbe.exe* and will be installed in the *C:\Program Files\Renishaw\WiRE 2.0\Tools* directory. The program can either be launched from within the WiRE™ program via the button shown below, which is added to the spectrometer control software's toolbar, or it can run as a standalone application on a separate, more convenient PC. For example the SEM or EDS control computers.



Figure 25 - SCA control program button icon

When launched the program displays the dialog box shown below.

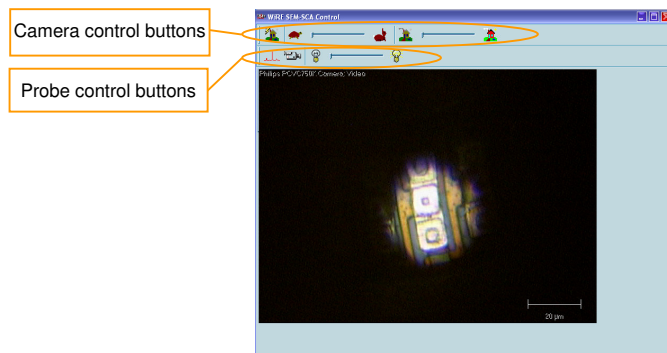

Figure 26 - SCA control program dialog box

If no video image is displayed when video mode is selected the camera may not have been initialised; please refer to section 3.4.3 for details. The probe control toolbar is shown in Figure 27, the camera control toolbar is shown in Figure 28. Their operation is described below.



Figure 27 - Probe control toolbar

The mode selection buttons switch between *Video* and *Spectroscopy* modes. The slider control changes the illumination level by increasing the power to the light source.

When selected, the *Spectroscopy Mode* button switches off the video display and the white-light source, and moves a steering mirror so that full laser power is directed onto the sample. When selected, the *Video mode* button (shown "pressed" in Figure 27) automatically switches on the white-light source, and activates the video in Windows™ display.

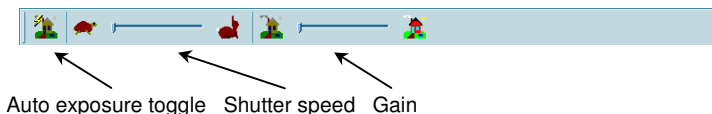

Figure 28 - camera control toolbar

Depending on the sample and the laser, it may be necessary to alter the camera settings for the white-light video display. This can be carried out using the controls shown in Figure 28 (*Auto exposure* needs to be disabled before the shutter speed or gain can be adjusted).

The *Auto exposure toggle* switches the automatic shutter and gain control off and on – typically *Auto mode* is used when first setting the analytical working distance (see section 3.5.1 for details).

As the *shutter speed* is increased (moving the cursor to the right), the image will tend to become noisier and it will be harder to see faint objects. As the *gain* is increased (moving the cursor to the right) then the image will become noisier, but faint objects will become easier to see.

In order to see the white light image and the laser spot at the same time, it is usually necessary to have a fairly high level of white light illumination (see the description of Figure 27 above), and to attenuate the laser (see section 3.4.2 for details).

Alternatively, the full camera controls may be accessed by a right click in the video display area, then left-click on properties to display the *Video Viewer Properties Dialog* (see Figure 20), then click on the *Video Source* tab (circled orange in Figure 20) to display the dialog shown in Figure 29.

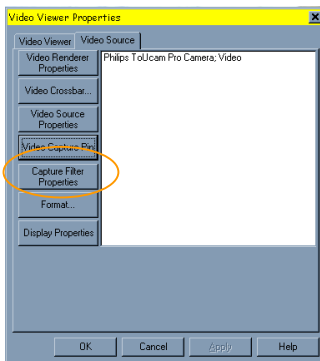

Figure 29 - Video Source dialog

The *Video Viewer* dialog (shown in Figure 20) should not be altered from the default settings.

The correct settings for the *Video Capture Pin* are described in section 3.4.3 - Initialising the VCFOP software, and with the exception of the *Capture Filter Properties* button (circled in orange in Figure 29), the other buttons have no function for the VCFOP. Clicking the *Capture Filter Properties* button will display the dialog box shown in Figure 30.

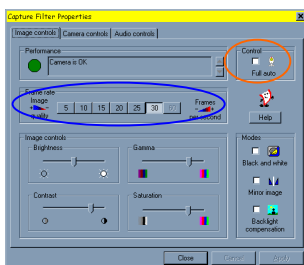

Figure 30 - Image Control dialog

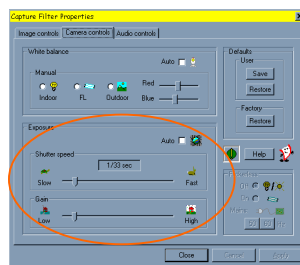

Figure 31 - Camera Controls dialog

In order to adjust the camera settings, the auto controls need to be disabled - uncheck the *Full Auto* box shown circled in orange in Figure 30 - Image Control dialog. The key camera controls are the *Frame Rate*

adjusted by the buttons circled in blue in Figure 30 - Image Control dialog, which principally affects the real-time response rate of the camera, and the *Gain* (signal to noise). Faster frame rates will yield a better real-time response, but poorer signal to noise and sometimes a less intense image (which is desirable if the aim of setting the controls manually is to reduce the spot intensity for example).

The other key control is the *Exposure*, the controls for which are circled in orange in Figure 31 - Camera Controls dialog. Firstly disable the *Auto* settings by un-checking the box to enable the *Shutter Speed* and *Gain* to be adjusted. Setting a faster *Shutter Speed* will reduce the image brightness, but will also decrease the signal to noise, the *Gain* may have to be increased to compensate for reduced brightness, but this will also tend increase the noise. Setting a slower *Frame Rate* (see above) will improve the signal to noise.

Any adjustments made to the *Camera Controls* will be maintained *unless* the PC is switched off, in which case the software will need to be re-initialised (see section 3.4.3) and the custom *Camera Controls* reset manually.

3.6. Changing Laser wavelengths

The SCA supports single or dual laser wavelengths (e.g. 514 nm or 532 nm and 785 nm) or dual techniques (i.e. Raman/PL and CL – UV or VIS). With Renishaw's *inVia* spectrometers and SEM-SCA changing laser wavelengths is very straightforward due to extensive automation. Changing between analytical techniques involves a little more user intervention and is described in sections 3.7 and 3.8 below.

3.6.1. Spectrometer set-up

For *inVia* spectrometers the default conditions (e.g. slit widths, gratings etc.) for the techniques supported will have been set-up during installation of the hardware and WiRE 2.0 software. Technique selection is made using the drop down toolbar in the *sample review* dialog box (see Figure 14). It is possible that changing from one wavelength to another will require changing the lens set in the spectrometer – if this is required a prompt describing the changes needed will be displayed by the WiRE 2.0 software (see also the electronic *WiRE 2.0 User Guide* for further information).

To switch between standalone and SCA operation of the *inVia* spectrometer, the steering mirrors on the rear arm need to be moved to the appropriate positions as indicated in Figure 32.

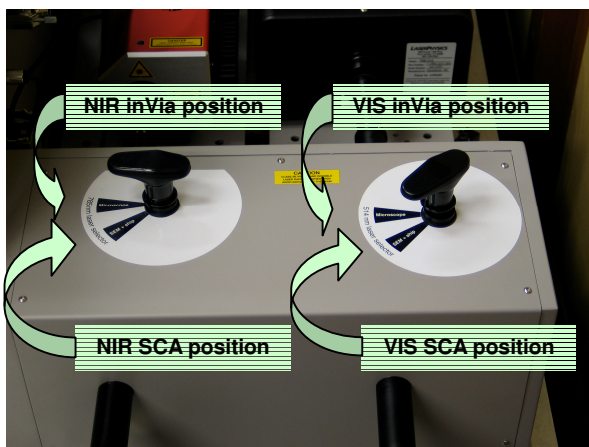

Figure 32 - *inVia* rear arm showing position of steering mirrors

3.6.2. SCA set-up

For dual Raman systems (VIS/NIR) no physical adjustments are necessary to switch wavelengths (changing the steering mirrors on the *inVia* rear arm effectively sets up the SCA – see section 3.6.1 for details)

The *Vidprobe.exe* program, running either as part of the WiRE 2.0 software, or as a standalone application – is used to switch between white light imaging and spectroscopy modes as described in section 3.5.3.

3.7. Set-up for VIS/UV-CL and PL spectroscopy

For SCA systems that provide Raman spectroscopy as well as cathodoluminescence (CL - either VIS or UV) and photoluminescence (PL), both the SCA and *inVia* will have been modified to optimise performance. CL and PL require that the SCA has a VIS or UV CL CSMCFOP (confocal single mode compact fibre optic probe) fitted.

3.7.1. Spectrometer set-up

Technique selection is made using the drop down toolbar in the *sample review* dialog box (see Figure 14). It is possible that changing from one technique to another will require changing the lens set in the spectrometer – if this is required a prompt describing the changes needed will be displayed by the WiRE 2.0 software (see also the *WiRE 2.0 User Guide* for further information).

To provide an excitation source for PL excitation, the Raman source (VIS or NIR laser needs to be selected for SCA operation on the rear arm of the *inVia* spectrometer.

3.7.2. SCA set-up

SCA systems supporting CL/PL have a three-position technique selection mechanism that is adjustable without having to remove the SCA covers - the externally visible parts of mechanism are shown in Figure 33. The mechanism is adjusted simply by moving the Raman/PL-CL *technique selection rod* to either the *CL* or *Raman/PL* positions. With the *technique selection rod* in the *CL* position, then the *Raman-PL selection handle* may be pulled and rotated to either the *PL* or *Raman* positions. The *technique selection rod* should only be moved using the “mushroom knob,” take care that the rod is properly engaged in the Raman-PL position.

IMPORTANT - The *Raman-PL selection handle* must only be “pulled and rotated” when the *technique selection rod* is in the *CL* position

Ensure the *Raman-PL selection handle* engages properly in its kinematic mount before returning the *technique selection rod* to the Raman/PL-CL position.

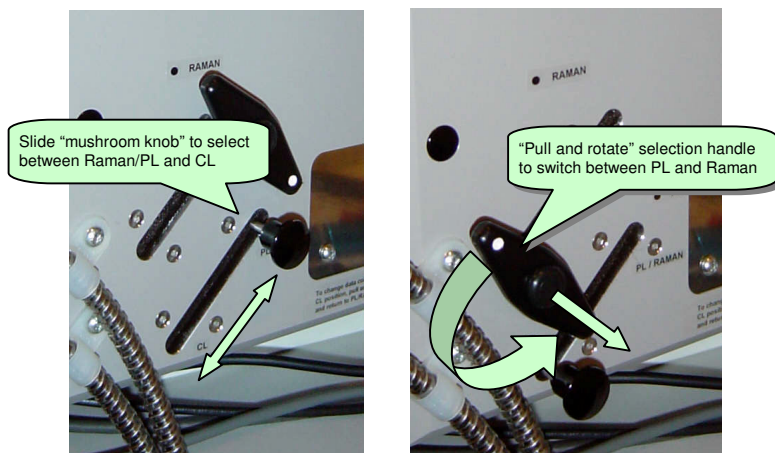

Figure 33 - The three-position technique selection mechanism

When the technique selection mechanism is in the “Raman” position the system is configured for full power laser excitation and optimised for Raman spectroscopy.

When the technique selection mechanism is in the “PL” position the system is configured for up to half full-power laser excitation, and data collection using the CL probe (which has no Rayleigh filters fitted). It may be necessary to attenuate the laser (see section 3.4.2) to avoid oversaturating the Renishaw CCD detector.

When the technique selection mechanism is in the “CL” position the system is configured for CL data collection using the CL probe (which has no Rayleigh filters fitted) – no laser light is incident on the sample.

IMPORTANT – There is some leakage of laser light within the *Video-Probe* so the laser should be fully blanked using the ND filters (see section 3.4.2) to avoid seeing emissions from the laser.

3.8. Procedure for VIS/UV-CL mapping

For CL mapping the Renishaw *inVia* system uses an auxiliary photomultiplier-type detector, this type of detector is particularly sensitive to low light levels, can handle a wide dynamic range of signal input, and

reacts quickly to changes in signal input level. The auxiliary detector is fitted to the *inVia* CCD arm using a kinematic location system.

3.8.1. Spectrometer set-up

It is advisable to collect a CL spectrum before starting CL imaging (see section 3.7), this will allow the position(s) of the characteristic CL peak(s) to be determined.

The principle of CL mapping is to set the spectrometer to collect light only from a particular wavelength, and then to scan the electron beam over the sample, collecting and displaying the CL signal intensity in synchronism with the scanning. With the Renishaw system, the scanning is controlled by specialist software, which controls the position of the electron beam, the positioning of the grating, and collection of the auxiliary detector output.

To collect the CL signal an auxiliary detector needs to be placed in position. Figure 34 shows the CCD arm (on the right hand side of the spectrometer) with its light-tight cover in position. This cover should be removed, and the auxiliary detector put in its place, making sure that the micrometer head is positioned towards the main body of the spectrometer (as shown in Figure 35). The detector assembly engages kinematically thereby ensuring the slit and detector alignment is precisely maintained. Finger-tighten the locking screws front (shown in Figure 35) and rear – these are to prevent accidental exposure of the photomultiplier to room lights. Once the detector is in place and the lock-screws tightened, it is safe to connect the detector to the power supply. The other connections to the Raman PC will have already been set up during installation.

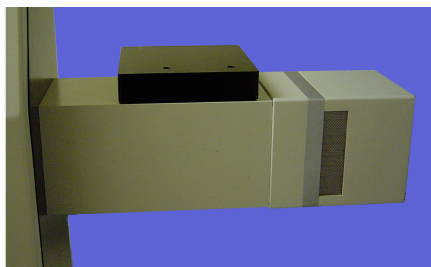

Figure 34 – CCD arm - detector cover in position

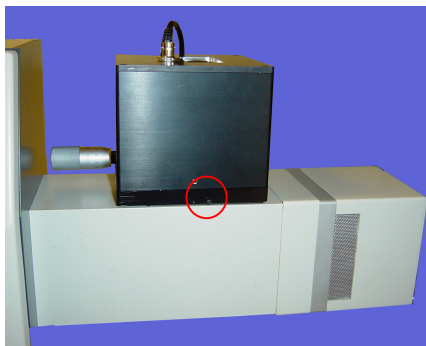

Figure 35 – CCD arm - auxiliary detector in position (lock-screw circled)

in red)

3.8.2. SCA set-up

The three-position technique selection mechanism (see Figure 33) should be set to the “CL” position (see section 3.7.2 for details) the system relies upon the SEM electron beam to generate photons, and the CL probe - which has no Rayleigh filters fitted - collects these. It may be necessary to reduce the SEM probe current to avoid oversaturating the Renishaw CCD detector.

3.8.3. SEM and MICA software set-up

Generally speaking, when initially setting up for CL imaging, it is preferable to use high SEM probe-currents to ensure a high count-rate this will make it easier to confirm that the CL imaging is working correctly. Once this has been established, the SEM probe-current can be reduced to reduce the spot size (and hence spatial resolution). Adjusting the SEM accelerating voltage will change the CL sampling depth.

The SEM scanning control, grating position set-up, and photomultiplier detector output collection are controlled by the *MICA* software application. Clicking on the desktop icon launches the software.

After the start-up page, the main *MICA* dialog box is displayed. Click on the *Help* menu to display detailed help for the *MICA* program. Click on the *Conditions* menu item, and then select *Imaging/Mapping* to display the dialog box shown below in Figure 36.

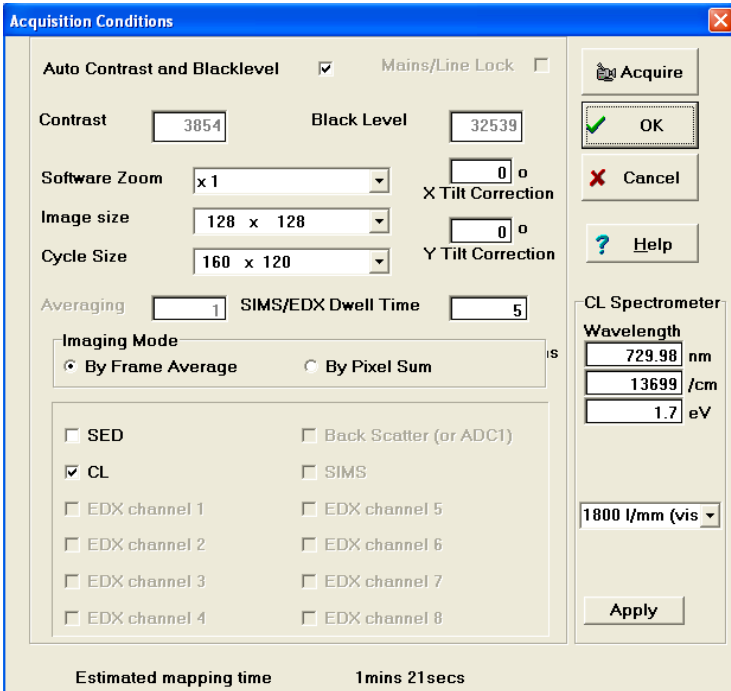

Figure 36 – The *MICA* imaging and mapping control dialog box

For CL imaging, the key parameters that need to be set are the grating position (*CL Spectrometer - Wavelength* - see section 3.7 for details), the *Image size*, and the *Dwell Time* per pixel – these are all set from within the *MICA* imaging and mapping control dialog box.

The CL image size would normally be set either to 128x128 or 256x256 pixels although other sizes can be set.

The dwell time per pixel can be set from 1 ms to 100 ms the value selected will alter the total acquisition time (which also depends on the image size). Depending on the magnification of the image, the predicted SEM drift should also be factored-in to the choice of dwell time (most SEMs drift approximately 5 micrometres per hour).

Once the grating position, image size, and dwell time per pixel have been set, then pressing the *acquire* button will collect the CL map. Once the map has been collected, it should be saved as a *.map* file – this retains the

16-bit data depth. The image is *displayed* using a Windows™ dialog box and is restricted to an 8-bit greyscale viewer – the contrast and brightness controls can change the visualisation of the 16-bit data but can seldom reflect the true depth of information that is available in the 16-bit data. If the data is saved as a *bitmap* (.*bmp*) then the 16-bit information is lost.

It is also possible to save the images in *.raw* format – this stores the data as an array of 16-bit words with two words as header defining the image width and height in pixels. These *.raw* files can be visualised using more sophisticated third-party image processing programs.

4. Calibration

This section of the *User Guide* is concerned with calibration of the SCA system. The system "*health check*" provides a rapid means of determining whether the system is behaving normally, or whether a service or maintenance visit is required. Setting the *analytical WD* should only be necessary infrequently - the Renishaw retraction mechanism will not alter with time, but it may be necessary to set up new objective lens DAC values for alternative accelerating voltage and probe current settings. The requirement to set the *analytical position* will depend on the level of accuracy required in Raman analysis. The Renishaw collection optics will not change position with time, but the SEM may "drift" on an hourly and daily basis - this drift is likely to be micrometre-order, so depending upon the analytical precision required, this will determine the calibration regime.

4.1. Silicon signal check (system "health check")

The easiest way to carry out a "health check" of the SCA is to collect a spectrum from a clean silicon sample. For *inVia* spectrometers, the slits will be set to the default value of 70 micrometres (see the *Spectrometer User Guide* for further information), and the default grating will be set up. The *installation report* supplied when the SCA was originally fitted will have recorded the performance on silicon, this should be used as a reference.

Put a clean silicon sample in the SEM (use the sample holder insert for example) and optimise the laser spot using the *direct* method (see section 3.5.1 for details). Check that the SCA shutter is open, and that the laser is running at full power and that the beam is not attenuated (see section 3.4.2 for details), then use the WiRE™ software to set up a 10-second static scan centred at 520 cm^{-1} . Collect a spectrum, and measure the silicon peak intensity. The silicon peak intensity should not vary over time by more than $\pm 10\%$ (with respect to the value measured at installation) - if it does, then contact the local Renishaw service centre for advice.

4.2. Setting the analytical WD

The Renishaw collection optics are designed so that their position in space (X, Y, Z) will not change with time. SEMs, however, will "drift" with time,

some drift is mechanical, some is electrical, and some is attributable to the sample, these variations need to be accommodated in order that the *analytical WD* matches the optimum focus of the SCA optics.

SEMs typically have two methods of measuring the working distance, a Z-sensor on the sample stage, and a Z value calculated from the objective lens excitation for a given accelerating voltage. For Raman spectroscopy, the stage Z-sensor is too inaccurate, especially because it assumes that the top of the sample is exactly level with the top of the sample holder and this may not be the case.

There are also issues where the Z value is calculated from the objective lens excitation. The Z value needs to be calculated as a function of accelerating voltage (higher voltages need higher lens excitation to maintain the same effective focal length), and this calculation normally uses a look-up table based on typical column performance. Secondly, electromagnetic lenses can become slightly magnetised resulting in hysteresis in the normally linear excitation versus magnetic flux relationship, and this affects the actual focal length for a given excitation. All SEMs, however, provide a *lens clear* function for removing hysteresis.

These considerations mean that it is difficult to calculate the effective focal length of the SEM objective lens (i.e. the working distance) to much better than 100 micrometres. A calculated WD therefore, will only set the effective focal length *close* to the *analytical WD* required for the SCA.

If the SEM provides the means to read the DAC (digital to analogue converter) settings that actually control the lens excitation, however, these values can be used to set accurately the focal length (WD) of the objective lens to the *analytical WD*. It must be emphasised, however, that the DAC settings are specific to a particular accelerating voltage, and that the objective lens must not be hysteretic (i.e. the *lens clear* function needs to have been activated). If the functions mentioned above are not applicable to the SEM to which the SCA is fitted (see also [Appendix B](#) for details), then the *analytical WD* must be set using the *direct* method, which is described in detail in section 3.5.1. Use the silicon sample attached to the SCA sample holder provided by Renishaw to determine accurately the *analytical WD* and then *without altering the focus of the SEM* use the stage Z control to focus the region of interest on the sample to be analysed.

4.3. Setting the analytical position

For the Renishaw SCA the *analytical position* remains effectively invariant - the design ensures that the positioning in space of the collection optics is reproducible to sub-micrometre accuracy. The SEM image, however, may move with time depending on the stability of the SEM electronics, the stage, and the sample. Furthermore, depending on the accuracy of the electron optical column, the image may shift when either the accelerating voltage or probe size are adjusted.

For W and LaB₆ instruments when the filament is changed, and as a new filament conditions for the first few hours of use, the absolute position of the SEM image gradually changes. Consequently the SEM image position with respect to an absolute position in space (as established by Renishaw's collection optics) can alter by tens of micrometres from a previously established position.

For these reasons the *analytical position* - specifically, where the laser spot hits the sample with respect to the SEM image - needs to be set up and reviewed at appropriate intervals. There are two methods to determine the *analytical position* - the *direct* and *indirect* methods.

The *direct* method is very straightforward, a feature visible in the white-light image that can be unambiguously correlated with the SEM image (for example the integrated circuit on the sample insert) is positioned under the laser spot (visible in the white-light image). Where the area illuminated by the laser on the feature appears in the SEM image, is where the *analytical position* is located. The limitations of this method are that the white-light image has only approximately 2 micrometres resolution, and that many samples do not have sufficient contrast or small enough visible features in the white-light image to allow correlation with the SEM image.

When the *direct* method cannot be employed, the *indirect* method must be used. The *indirect* method requires a discontinuity (typically a silicon cleaved edge, or a feature on the integrated circuit on the sample insert) across which the laser spot can be moved using the SEM X/Y stage to observe when the spot is extinguished in the white-light image. The position at which the spot disappears is then be correlated with the position of the edge on the SEM image. The procedure for the *indirect* method is shown by the flowchart in Figure 37.

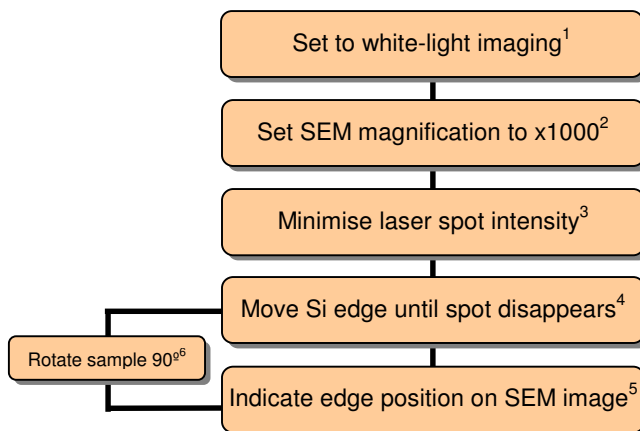

Figure 37 - Flowchart showing *indirect* positioning of laser spot

1. Set to the SCA to white light imaging - use the SCA control program (see section 3.5.3) to select video mode for the SCA.
2. Set the SEM magnification to x1000 - this is the default magnification for setting the laser spot position. Other magnifications can be selected, but the chosen value *must* somehow be indicated on the SEM image
3. Minimise the laser spot intensity by adjusting the *Video Viewer* controls (see section 3.5.3) and/or the laser attenuation controls (section 3.4.2)
4. Move the silicon edge using the SEM X or Y control until the white light image of the spot disappears [this implies that the laser spot is falling on the silicon sample at the beginning of the procedure]. Note that SEM stages typically have 1 micrometre to 2 micrometres backlash, so it is important that the X or Y movement is carried out from one direction only, having taken-up any backlash. Note also that motorised stages may have smaller software steps than hardware steps, and this will affect the precision to which the laser spot position may be set.

Indicate the silicon edge position on the SEM image when the laser spot disappears from the white light image. Depending on the SEM

implementation (see [Appendix B](#)) this may involve defining a graphic overlay file, or devising a hardware implementation to indicate the laser spot position

5. After setting the laser spot position in one axis, the sample should be rotated through 90° to set the laser spot position on the perpendicular axis using steps 4 & 5 above

The frequency with which the laser spot position needs to be reviewed depends principally upon the precision to which the spot position needs to be known in order to analyse with confidence the regions of interest on a sample. As has been explained above, whilst the positioning of the SCA collection optics is effectively invariant, the position of the SEM image can vary with respect to the absolute position of the sample.

If the effects of stage, electronics, thermal, and sample drift are ignored (a fair assumption for a SEM that has been allowed to warm up sufficiently, and has securely-attached samples), then the main factors that influence the SEM image position are gun alignment, and spot size and accelerating voltage. Although individual SEMs vary, in general the image shift caused by changing accelerating voltage is typically 2 micrometres to 5 micrometres, and the same for changing spot size [these parameters are typically additive]. For gun alignment [filament tilt and shift adjustment] the figures can be up to two orders of magnitude higher.

Another *critical* consideration is the objective lens aperture alignment, and correction of lens hysteresis. If the aperture is not correctly aligned, or if hysteresis is not corrected, then SEM image shifts of *tens of micrometres* are possible - it is imperative that these parameters are correctly set, but once they are set, then their influence on the image position can be disregarded.

Given the above, then the *analytical position* should be reviewed as follows:

If *micrometre order* analytical spatial resolution is required, then the position of the laser spot must be determined for the exact SEM conditions used to image the sample - specifically accelerating voltage, spot size, and gun alignment. It is also essential that the sample is securely mounted and is not charging, and that the SEM is fully temperature stabilised, and that the filament has not recently been changed.

If *3 micrometres to 5 micrometres order* analytical spatial resolution is required, then the position of the laser spot needs to be determined at the beginning of the analytical session. Changing the spot size and accelerating voltage should not result in the indicated SEM image position differing from the *analytical position* by more than the required positional accuracy. If the filament is new, however, or if the gun alignment is changed, then the system will need to be recalibrated. If the sample is not securely attached to the sample holder, or if the sample is charging, then the positional accuracy may not be sufficient after approximately 10 minutes. It remains important that the objective lens aperture is correctly centred, and that lens hysteresis has been removed.

If *5 micrometres to 10 micrometres order* analytical spatial resolution is required, then the position of the laser spot from the last analytical session can be used *provided* neither the filament nor the gun alignment have been changed. It remains important that the objective lens aperture is correctly centred, and that lens hysteresis has been removed.

If *greater than 10 micrometres order* analytical spatial resolution is required, then the position of the laser spot from the last analytical session can be used *provided* neither the filament nor the gun alignment have been changed.

If the filament is changed, and if it is known that the filament drifts for the first few hours of its life, then re-calibration of the *analytical spot position* must be carried out regularly until the filament (and hence the SEM image) has stopped drifting.

Appendix A - Specifications

Optical Repeatability		<0.5 micrometres
Optical stability		
short term		<0.5 micrometres in 10 minutes
long term		<2.0 micrometres in 8 hours
White light image		
Resolution		< 2.0 micrometres
Field		> 30 micrometres (for 200mm diameter chamber)
Laser spot size (FWHM)		< 2.0 micrometres
Retraction speed		< 5 mm/s
Pitching & snaking		< ± 1.0 mm
Working distance		
From SEM OL		As agreed value ± 0.5 mm
From OAP		>0.5mm to touch alarm
Touch alarm		
X		Automatic retract if touch sensed
Z		Audible alarm if touch sensed
Vacuum		
Integrity		SEM pump down time increase < 20%
Interlock		Vent disable/enable if optics inserted/retracted
Spectroscopy		
Power budget		>10%
Stability		<10% in 10 minutes, <20% in 8 hours
Performance		> 60 counts/second/mW ¹

¹ Clean silicon sample, VIS optics, 1800 g/mm grating, static scan, WiRE 2.0 \geq SP7, 70 micrometre slit

Appendix B - SEM implementation notes

JEOL JSR1000 (JSM-5610) Ehime University

Analytical Working distance

Nominal working distance:	20 mm
Actual working distance:	19.7 mm
Objective lens DAC settings:	OLF 2514, OLC 803 [x1K, 15 keV, spot 28]
Exchange working distance:	NA

Analytical position

Accelerating voltage:	15 keV	
Spot size:	28	
X offset (screen centre = 0):	4.4 μm	
Y offset (screen centre = 0):	8.4 μm	
Image shift as f (voltage):	est 2-5 μm - 5-30 keV	[Not measured]
Image shift as f (spot size):	est 2-5 μm - 20-80 units	[Not measured]
Image shift as f (magnification):	?? μm (X/Y) step at x??	[Not measured]
	?? μm (X/Y) step at x??	[Not measured]
Indication to users: (software)	X-hairs on <i>live</i> display (JEOL <i>Cursor</i>)	

Motorised stage

Make and model:	NA
Manual step size:	NA
Computer step size:	NA

External SEM control

Control method:		NA
Control program:		NA
Software functionality:	Magnification	NA
	OL current (coarse)	NA
	OL current (fine)	NA
	Spot size	NA
	Cross-hair position	NA
	Stage control	NA

Appendix C – Troubleshooting

There are a number of factors that can cause unexpected results when using the SEM-SCA. In order to confirm that a “problem” is real, it is advisable to collect a spectrum from a silicon sample from which the expected performance for a given set of conditions is known (see chapter 4.0 for details). This operation will frequently reveal oversights when preparing to collect spectra. If a problem is suspected, make sure that the laser power and silicon signals are measured before reporting it. The tables below show the possible causes and solutions for typical problems.

No recognisable Raman spectrum is collected (just noise)

Possible Cause	Solution	Ref.
The laser is physically shuttered	Open shutter	3.4.2
The steering mirrors on the rear arm are in the wrong position	Set the appropriate mirror to the SEM/ship position	3.6.1
CFOP 99.9% or 100% attenuated	Select OD 0 (0% attenuation)	3.4.2
The video probe has <i>sample viewing mode</i> selected	Select <i>data collection mode</i> for the video probe	3.5.3
Laser is not on or is warming up	Switch laser on, or wait	-
Fibre input is not selected for <i>inVia</i>	Select fibre input using the <i>sample review</i> toolbar	3.2
The SEM-Raman optics are not inserted	Insert SEM-Raman optics	3.4.1
The SEM-Raman WD is incorrect	Set height to the analytical WD	3.5.1
The sample is Raman inactive	Use another analytical technique (!)	-
The sample is a weak Raman scatterer	Increase the acquisition time or the laser power	3.5.3

The Raman signal levels are very low

Possible Cause	Solution	Ref.
The SEM-Raman WD is incorrect	Set to analytical WD	3.5.1
CFOP 99% or 99.9% attenuated	Select OD 0 (0% attenuation)	3.4.2
The laser power is low	Measure the laser power and the signal strength from silicon	4.1
The single mode launch has moved	Measure the laser power and the signal strength from silicon	4.1
The single mode fibre is damaged	Measure the laser power and the signal strength from silicon	4.1
The sample is a poor Raman scatterer	Increase the acquisition time or the laser power, or use another analytical technique	3.5.3

The Raman signals are very high

Possible Cause	Solution	Ref.
The sample is fluorescing	Select another laser wavelength or try quenching	3.6
The laser power is too high	Select a higher degree of laser attenuation	3.4.2
The sample is being burned (incandescence)	Select a higher degree of laser attenuation	3.4.2
Stray light is being detected	Switch off all in-SEM light sources	-
Cathodoluminescence from the sample is being detected	Switch off the electron beam	-

Various mechanical and electrical problems

Possible Cause	Solution	Ref.
The power light on the SEM-SCA is not illuminated	Check all cables are connected and switch on the SCA	2.2.1
The collection optics will not insert	Check the vacuum interlock cable is connected, and make sure SEM is pumped-down	-
The touch alarm sounds and the SEM-SCA collection optics will not insert	The SEM stage is too high! Drop the stage and retract the collection optics to the OUT position to reset	3.4.1
All indicators on the SCA status panel are flashing	The SCA is in manual mode, switch the power off and back on again to reset the SCA	2.2.1
The video probe will not switch between <i>sample viewing mode</i> and <i>data collection mode</i>	The video probe communications have failed – check all [USB] cables are connected, reboot the PC with the SCA connected and switched on, re-run the VideoP.exe program	-
No white light image is visible in <i>sample viewing mode</i>	The SCA camera is not initialised – re-run the initialisation procedure	3.4.3
No white light image is visible in <i>sample viewing mode</i>	The intensity of the WL LED is too low, turn the intensity up or the shutter speed or gain are too low, set to auto, or adjust manually	3.5.3

No laser spot is visible in the white light image

Possible Cause	Solution	Ref.
The video probe is set in <i>data collection mode</i>	Select <i>sample viewing mode</i> on video probe	3.5.3
The laser is highly attenuated	Reduce the laser attenuation	3.4.2
Laser not on or warming up	Switch laser on or wait	-
The laser is physically shuttered	Open the laser shutter	3.4.2

Appendix D – Weights and dimensions